

Nu-Cable™

Cable Barrier Systems

INSTALLATION MANUAL

CRP TERMINAL
Version 2014.09A



It's Our Nature. 

CONTENTS

<u>TITLE</u>	<u>SECTION</u>
TERMINAL INSTALLATION	
CRP	H
CHECKLIST	I
SYSTEM DELINEATION	J
APPENDIX	
DETAILS	L
SOILS	M
REPAIR	N
CONTACT	P

Nu-Cable™

Cable Barrier Systems

INSTALLATION MANUAL

SECTION H

3 OR 4-CABLE CRP END TREATMENT

CONTENTS

CRP ANCHOR INSTALLATION.....	2
Option 1: Driven CRP posts with soil plate	2
Option 2: CRP posts cast-in-place.....	2
Option 3: Precast CRP posts.....	3
SOFT SOIL FOUNDATIONS.....	4
CONNECTING CABLE ENDS	5
CRP ANCHOR END POSTS & FOOTER REINFORCEMENT	6
TL-3: THREE-CABLE CRP LINE POSTS	7
TL-3: FOUR-CABLE CRP LINE POSTS.....	8
TL-3: 4:1 SLOPE CRP LINE POSTS	9
TL-3: 4:1 SLOPE CRP LINE POSTS	9
TL-4 CRP LINE POSTS	10
TL-4 CRP LINE POSTS	10



It's Our Nature.® 

CRP ANCHOR INSTALLATION

There are *three* options for installing CRPs. They can be either cast-in-place, pre-cast or directly embedded (driven), depending upon project specifications.

CAUTION: The options shown below are examples of typical foundations for use in strong or weak soil conditions. They should not be assumed to be the only options available. If soil conditions at each anchor location are unknown or do not meet the minimum requirements for strong or weak soil as outlined in Section M, a geotechnical review by a professional engineer shall be conducted prior to starting installation. The results of this evaluation shall determine foundation design at each location.

Option 1: Driven CRP posts with soil plate

For permanent or temporary usage or where soil is known to be very strong, there is an option of installing CRP post without a concrete footing. The CRP post base is 96" (2438mm) long and has a 1/4" x 18" x 48" (6mm x 457mm x 1219mm) welded soil plate. Attach the CRP top to the base with the two 5/16" (8mm) breakaway bolts provided. Where soils are weaker than NCHRP 350 strong soil consult the manufacturer for special CRP post anchors that can be designed to appropriately meet the demands of the site soil conditions.

Direct Driven CRP foundations can be tensioned immediately after installation.



Option 2: CRP posts cast-in-place

In strong soil conditions drill 18" (457mm) diameter x 5'-0" (1524mm) deep hole. Place steel reinforcement as detailed on plan standard. Plumb posts and pour concrete. Be sure to not leave more than 4" (102mm) of the CRP post base exposed above the ground line. It is easier to plumb the CRP bases with the CRP top posts attached. Attach the CRP top to the base with the two 5/16" (8mm) breakaway bolts provided.



Option 3: Precast CRP posts

Use an 18" (457mm) diameter x 5'-0" (1524mm) form. Some contractors have found that modifying a standard section of 18" steel culvert pipe works well as a reusable form. Place steel reinforcement as detailed on plan standard. Plumb posts and pour concrete.

Be sure to not leave more than 4" (102mm) of the CRP post base exposed above the ground line. It is easier to plumb the CRP bases with the CRP top posts attached. The back fill material needs to be strong soil, compacted in 6" (162mm) lifts with a hydraulic tamper.



SOFT SOIL FOUNDATIONS

CRP foundations in soft soil should be a minimum of 8' in depth with an 18" diameter shaft; use 12" rebar cage reinforced with #5's at 6" O.C. with straps. Pouring a monolithic concrete pad for all three CRP post is also a viable option.

If full 8' 0" embedment is not available, use the following list to calculate the required concrete footing for each CRP:

- *For embedment less than 5':* Use a 4' wide x 3' deep monolithic concrete pad that spans the length of all of the CRP posts. It will need to extend 2' past each end CRP Post; total length being approximately 16.5'. Use #5 steel reinforcement bars equally spaced at 6" O.C.
- *For embedment depth of 5' to 5.9':* Drill a 48" diameter shaft. Use a 40" long rebar cage reinforced with #5's equally spaced at 6" O.C. with straps.
- *For embedment depth is 6' -6.9':* Drill a 36" diameter shaft. Use a 30" long rebar cage reinforced with #5's equally spaced at 6" O.C. with straps.
- *Embedment depth is 7' -7.9':* Drill a 24" diameter shaft. Use an 18" long rebar cage reinforced with #5's equally spaced at 6" O.C. with straps.

All concrete should be 3000 psi (25MPa) minimum and should cure for at least 7 days before tension is added to system.

CONNECTING CABLE ENDS

To connect the cables to the terminal, affix a cable end anchor to the end of each cable. Grease is recommended on all threaded rods to ease tensioning.



Insert the cable end anchor into the CRP post and through the L-Bracket, and install double nuts. The bottom cable shall be attached to CRP #3, the middle cable to CRP #2, and the top cable to CRP #1. Before putting final tension in system, ensure the L-Bracket is properly situated as show below.



Leave nuts as far down on the threads as possible to leave ample room for tensioning the cables. Run the cable along the ground to the respective turnbuckle location. Cut the cables and affix to one end of the turnbuckle. Attach the other end of the turnbuckle to the adjacent segment of cable and then connect the turnbuckle leaving the maximum amount of threads for tensioning. Repeat for all three cables to end of run.



Remember to use 1" threaded rod & hardware if using pre-stretched cable, or 3/4" hardware for standard cable.

CRP ANCHOR END POSTS & FOOTER REINFORCEMENT

Site specific soil testing shall be required prior to installation.

In strong soil conditions, use a minimum 5' 0" [1524] embedment depth or as designed by the project engineer.

In soft soil conditions, use a minimum 8' 0" [2438] embedment depth or as designed by the project engineer.

For all other locations, where the soil conditions are unknown or do not meet the minimum requirements, a site-specific anchor foundation must be designed by a professional engineer.

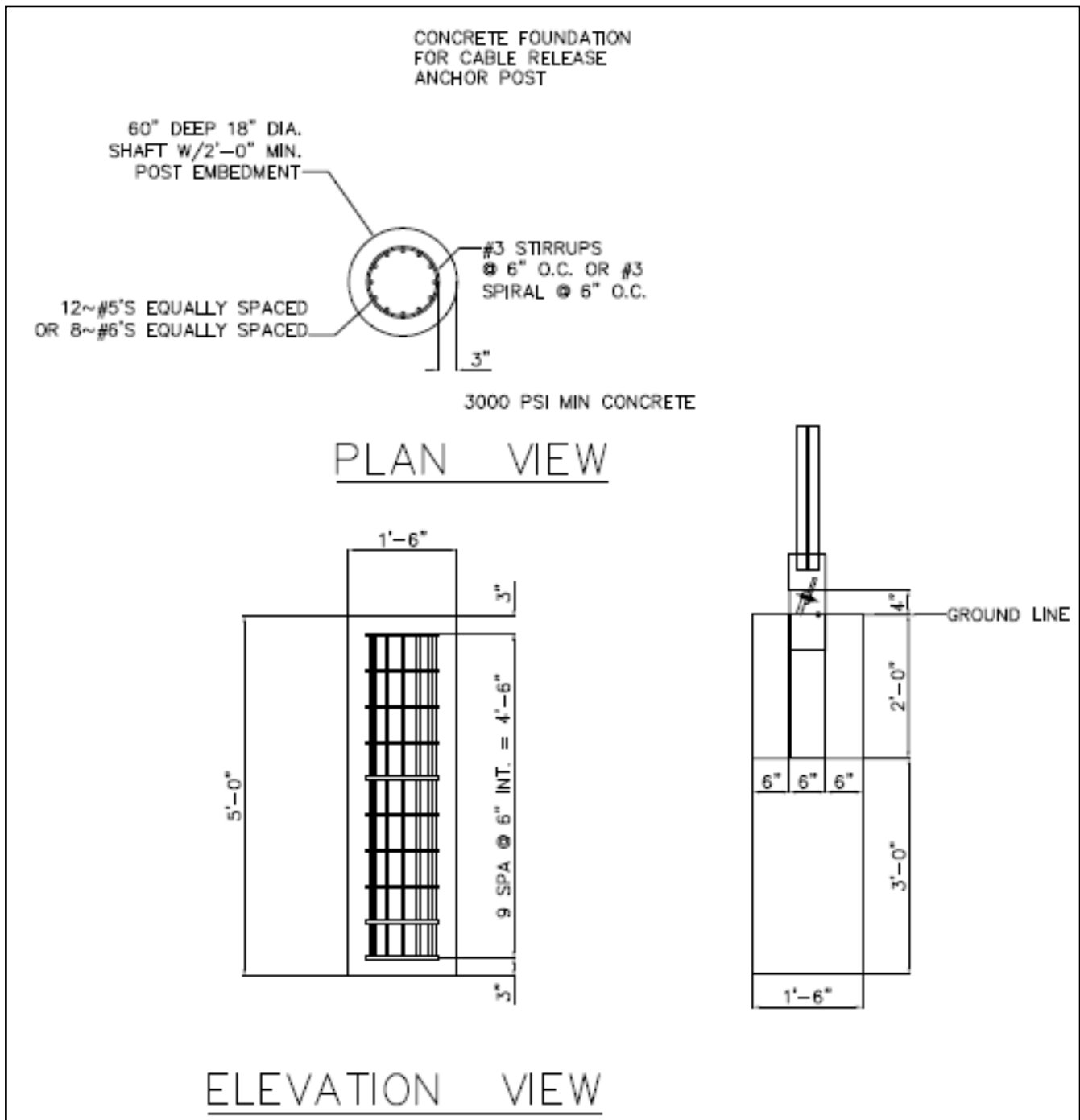

TL-3: THREE-CABLE CRP LINE POSTS

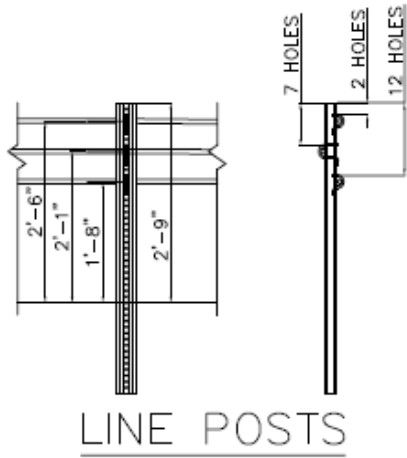

LINE POSTS

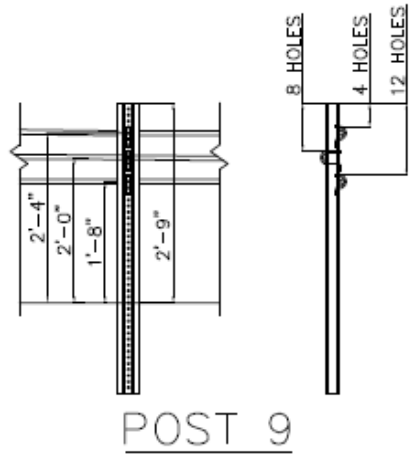

POST 9

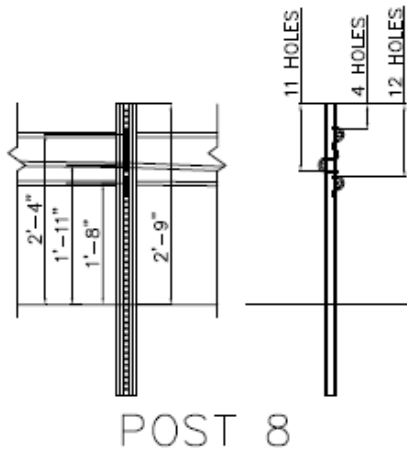

POST 8

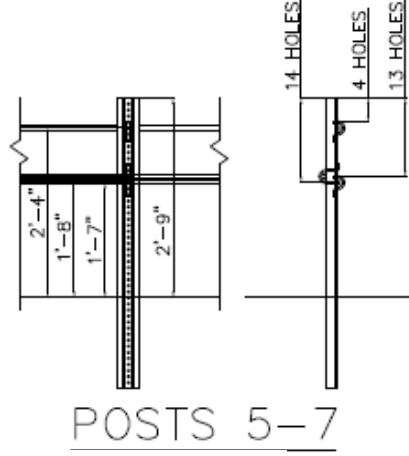

POSTS 5-7

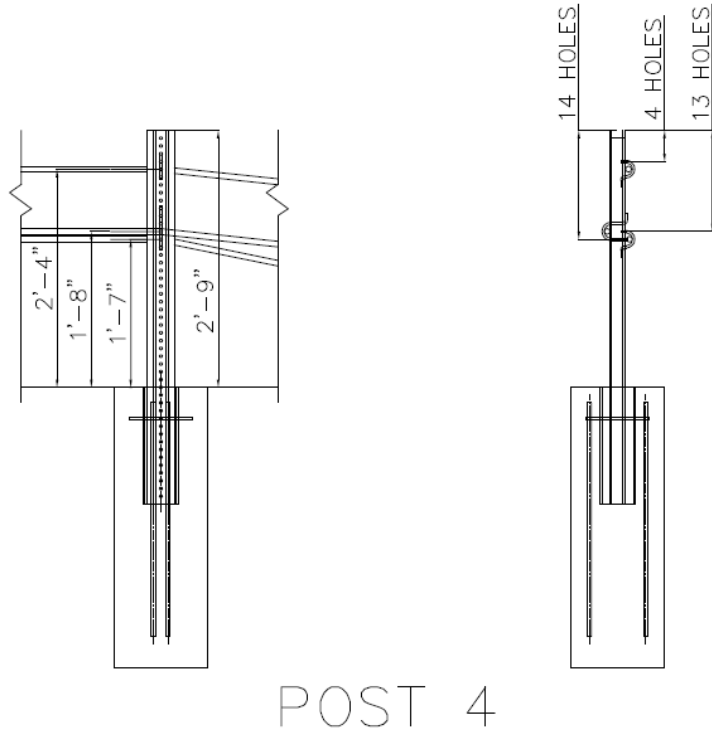

POST 4

TL-3: FOUR-CABLE CRP LINE POSTS

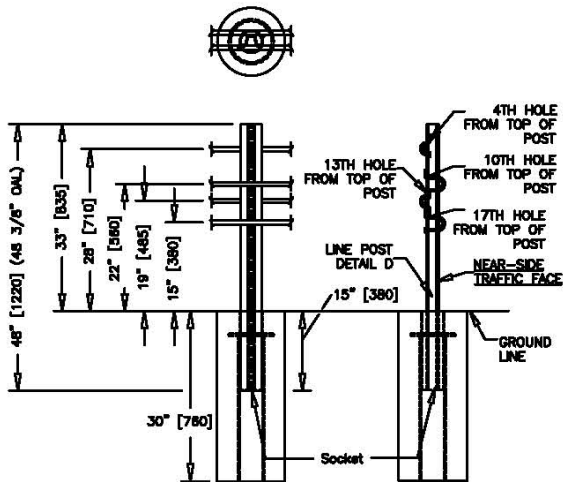

TERMINAL POST 5

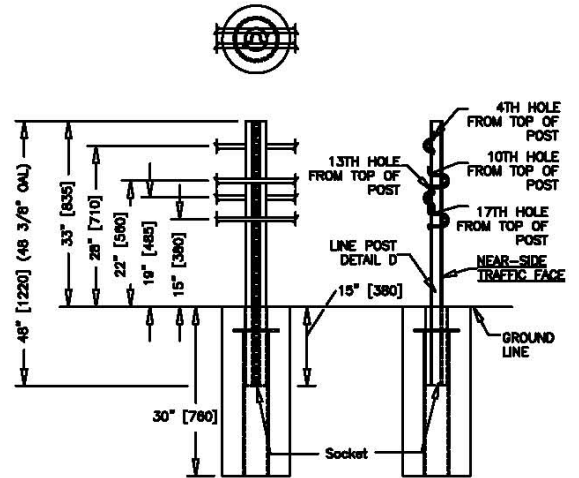

TERMINAL POST 6

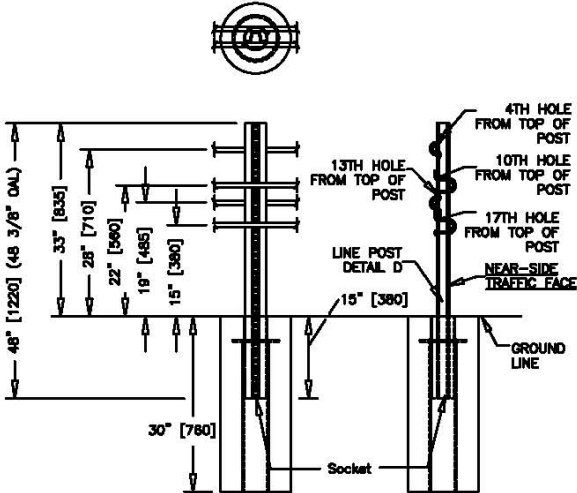

TERMINAL POST 7

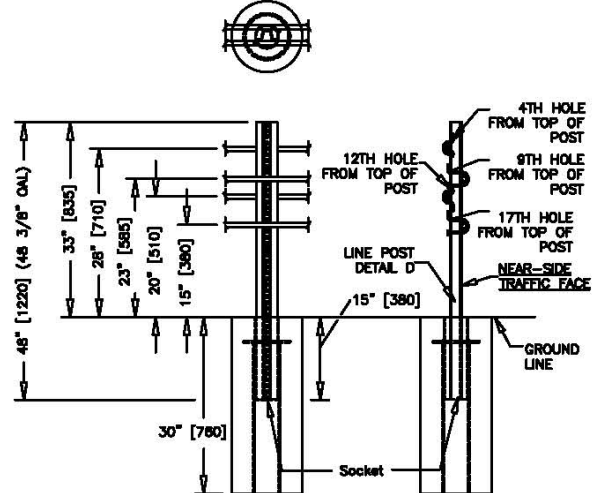

TERMINAL POST 8

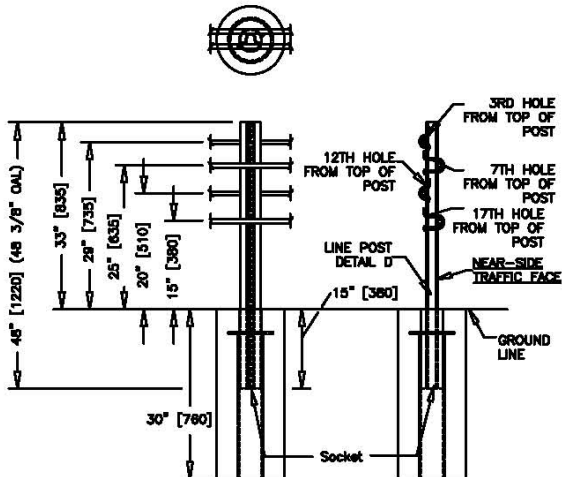

TERMINAL POST 9

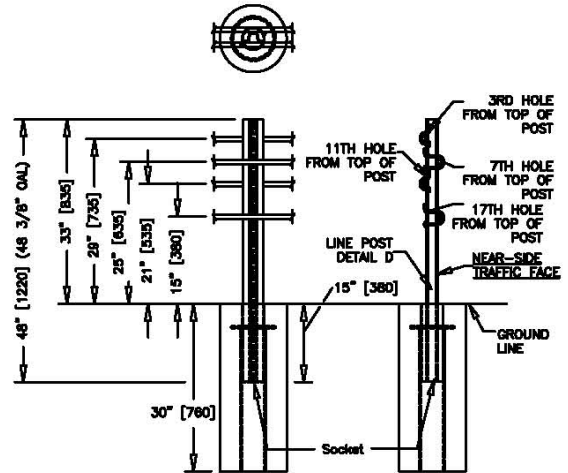

TERMINAL POST 10

TL-3: 4:1 SLOPE CRP LINE POSTS

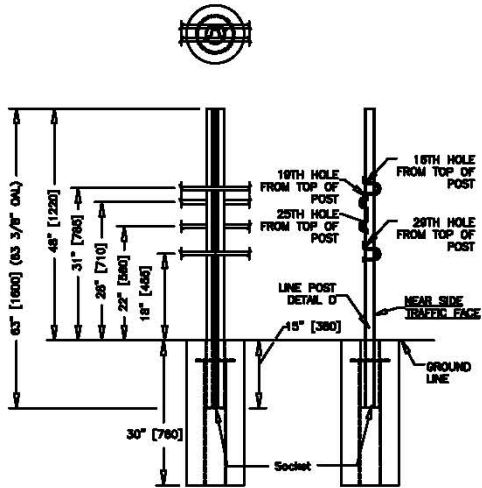

TERMINAL POST 5

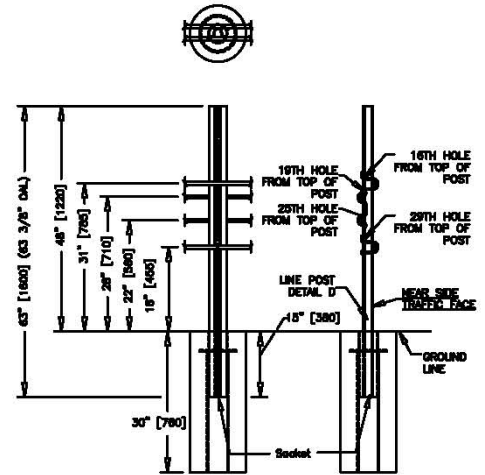

TERMINAL POST 6

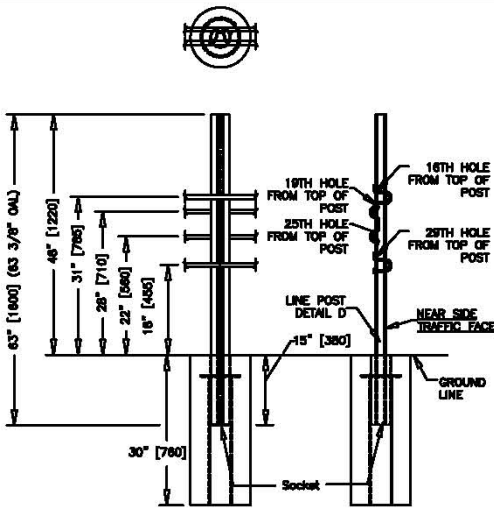

TERMINAL POST 7

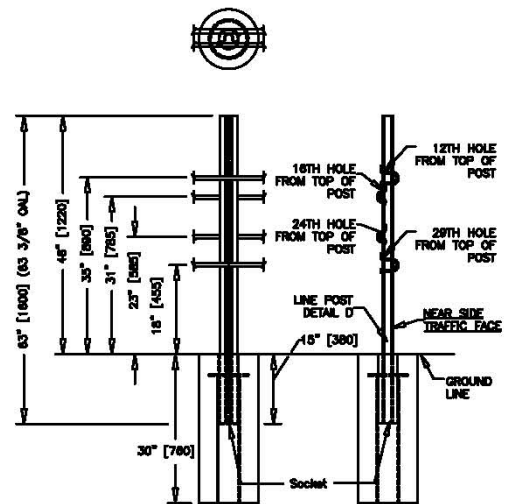

TERMINAL POST 8

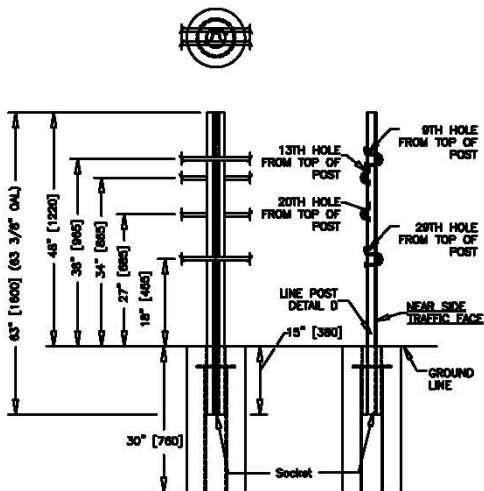

TERMINAL POST 9

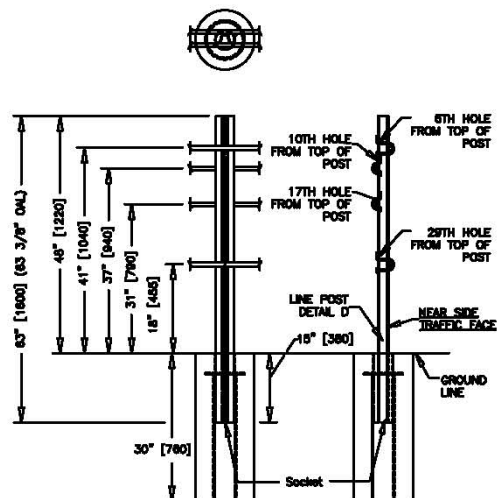

TERMINAL POST 10

TL-4 CRP LINE POSTS

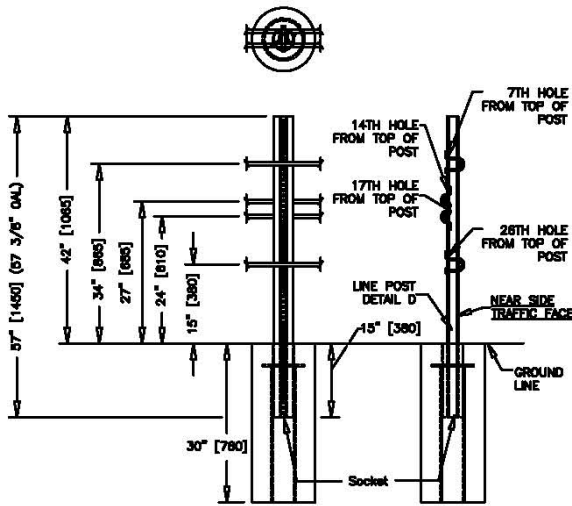

TERMINAL POST 5

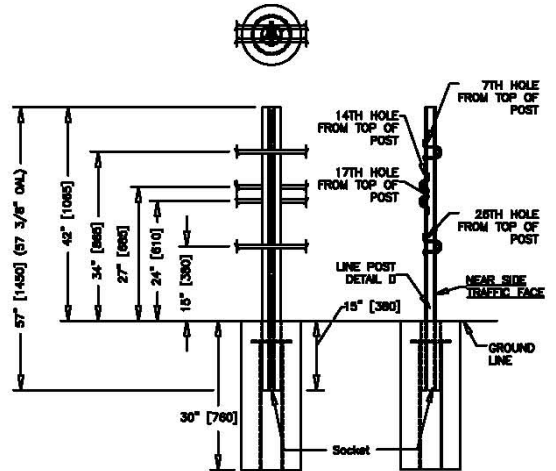

TERMINAL POST 6

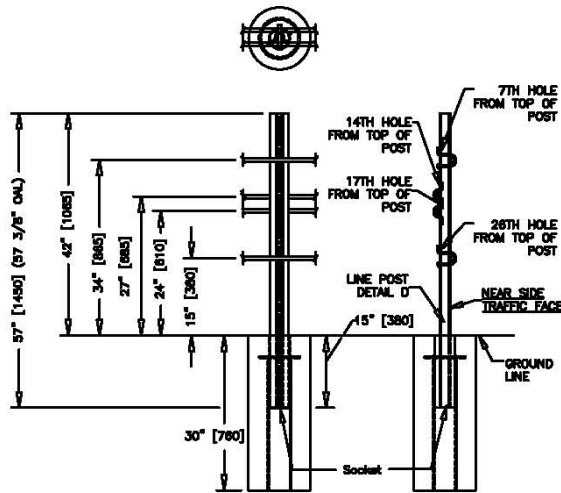

TERMINAL POST 7

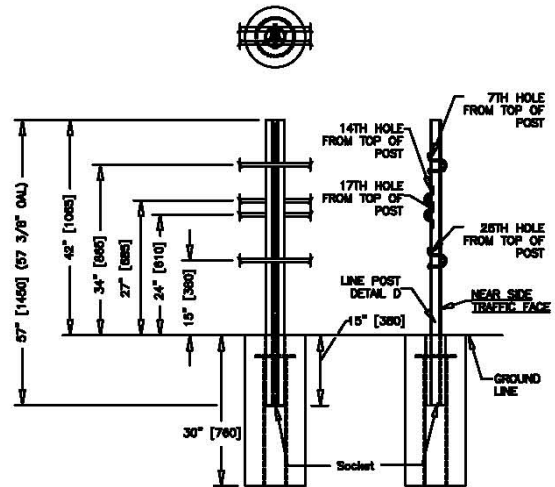

TERMINAL POST 8

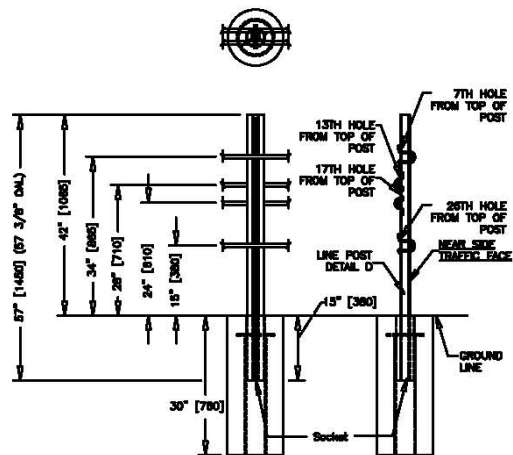

TERMINAL POST 9

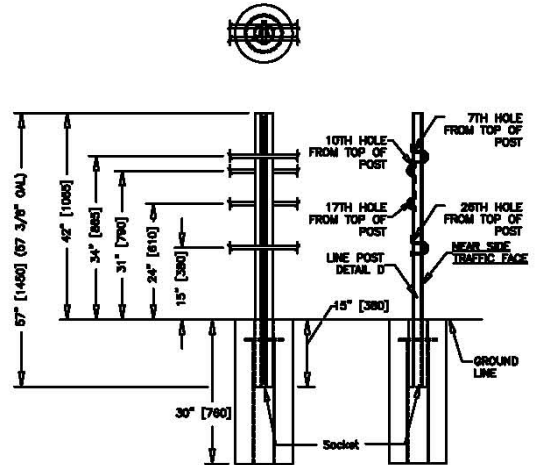

TERMINAL POST 10

Nu-Cable®

Cable Barrier Systems

INSTALLATION MANUAL

SECTION I TERMINAL SYSTEM CHECKLIST

CONTENTS

INSTALLATION CHECKLISTS	2
Terminal/Anchor Checklist	2



It's Our Nature. 

INSTALLATION CHECKLISTS

Terminal/Anchor Checklist

- Is there soil erosion around the end anchor? Eroded or disturbed soil should be replaced and compacted.
- Was the L-bracket installed with the CRP Posts?
- Did the CRP foundation move after tensioning the cable?
- Is the embankment depth such that no more than 4" of the base of the CRP post is exposed above ground level?
- Has the soil strength been taken into consideration with respect to the depth of the foundations?
- Does the foundation design meet the requirements of the project specifications and/or drawings?
- Was the concrete 3,000 psi (25MPa) and cured for a minimum of (7) seven days prior to tensioning the system?

NU-TEN® TERMINAL END:

- Has the trigger post been installed at the correct angle in the system?

Nu-Cable[®]

Cable Barrier Systems

INSTALLATION MANUAL

SECTION J SYSTEM DELINEATION

CONTENTS

DELINEATION.....	2
POST CAPS.....	3



It's Our Nature. 

DELINEATION

System delineation is not typically supplied with the Nu-Cable® barrier system due to the wide variety of delineation specifications between states. Delineation should be installed as directed by the engineer.

The bonding surface must be relatively clean and dry. Contaminated surfaces should be cleaned with a 50-50 Isopropyl Alcohol and water mixture. Use a lint-free cloth. Substrate temperature must be above 50 degrees F for proper adhesion.

Primer should be shaken well before using. Apply a thin, uniform coating to the bonding surface using the minimum amount that will fully coat the surface. Allow to dry completely before applying tape.

Remove backing from pressure-sensitive reflective sheeting and apply pressure by rolling or rubbing to ensure good contact.

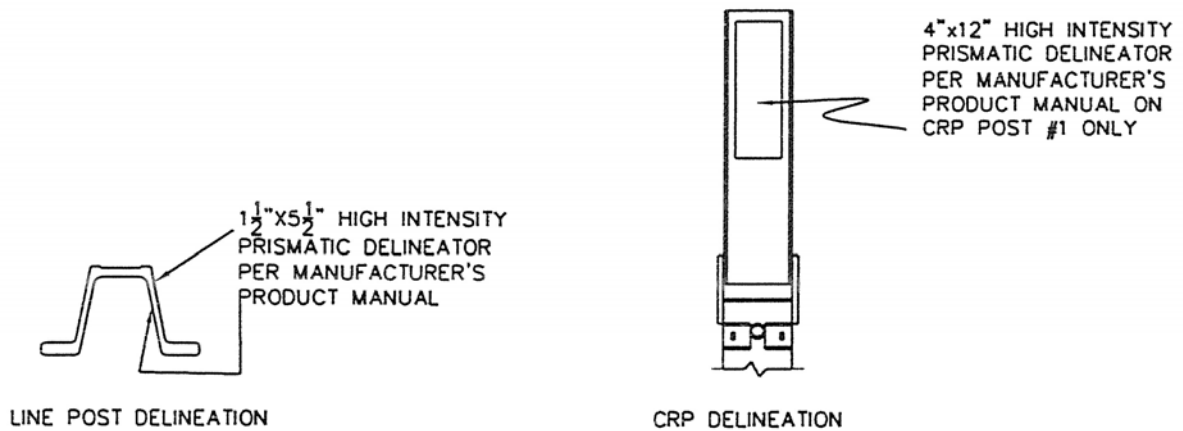

DELINEATION DETAILS

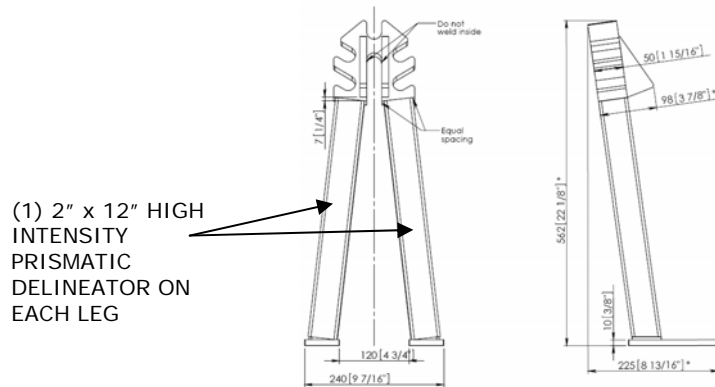

NU-TEN TRIGGER POST

POST CAPS

Optionally required based on project specifications.

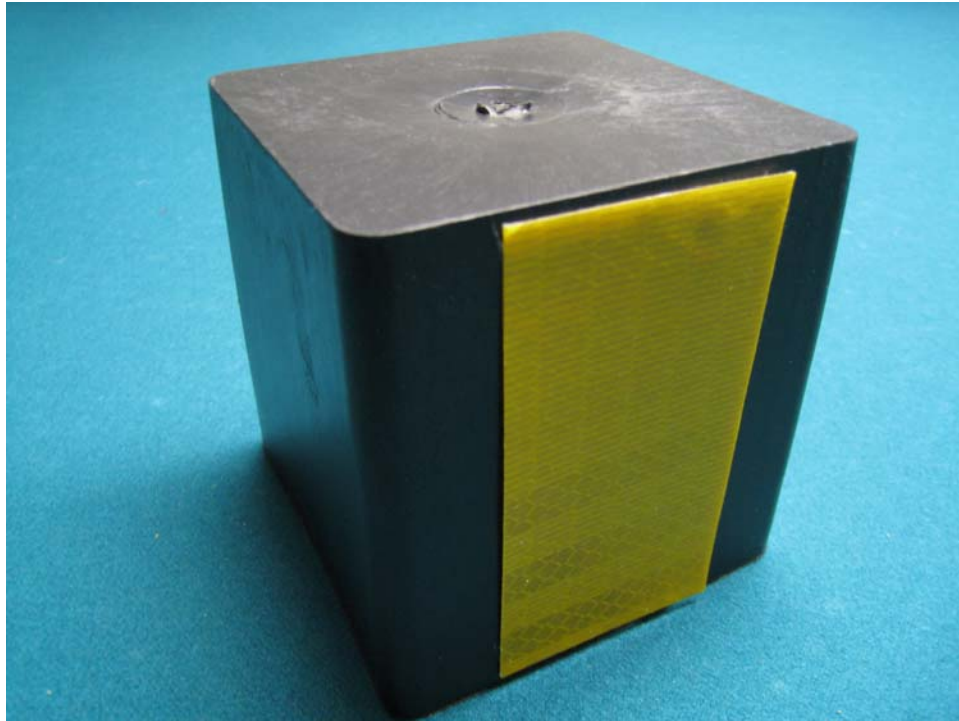

The Nu-Cable systems that only use hook bolts (TL3 – 3 or 4 cable for 6:1 slopes) have the line post firmly inside the center grooves of the cap.



The Nu-Cable systems that use hangers and straps (TL3 for 4:1 slopes or TL4 for 6:1 slopes) have the line post inserted all the way to the top of the cover utilizing the top grooves.



Adhesive is optional for securing the caps to the line posts.

Nu-Cable™

Cable Barrier Systems

INSTALLATION MANUAL

SECTION L
APPENDIX: SYSTEM DETAILS

CONTENTS

TL-3 SYSTEMS.....	2
TL-4 SYSTEMS.....	3



It's Our Nature. 

DETAILS FOR IDENTIFICATION PURPOSES ONLY. COMPLETE INSTALLATION DETAILS AVAILABLE FROM MANUFACTURER.

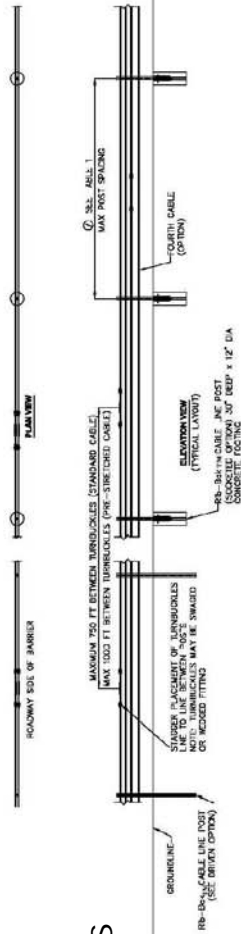

GENERAL NOTES

- For additional information, contact your distributor or Nucor Steel Marion, Inc. at (803) 439-8350.
- For payment see special specification "Cable Barrier System".
- For additional information see the manufacturer's product manual.
- The NU-CABLE System is designed for bi-directional traffic flows. See the manufacturer's product manual for placement adjacent to guardrail end treatments.
- The NU-CABLE System shall be installed on shoulders or medians with slopes of 6:1 or flatter without obstructions, depressions, etc. that may significantly affect the stability of an errant vehicle.
- The NU-CABLE System may be installed on either side of the roadway. Rib-Sag™ Cable Line Posts may be socketed or driven design.
- The Turn-Buckle-Cable and Four-Cable for 6:1 Slopes can use either a 48/LF or 56/LF post. See Table #1 for post size per spacing. The TL-3 Four-Cable for 4:1 slopes utilizes only the 48/LF post.
- See Table #2 for tension amount at specific cable temperature for initial installation.
- See Table #3 for tension amount at specific cable temperature for maintenance.
- Fourth (lowest) cable is optional. See project specifications for requirement of fourth cable.
- Consult your project plan sheets and cable barrier specifications for desired socket material.
- All foundation designs are based on NCHRP 350 strong (S1) soil. Consult the manufacturer for specific foundation designs if soil types differ.

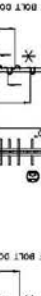
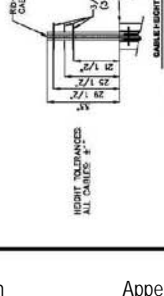
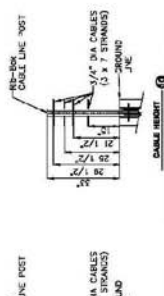
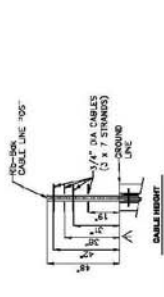
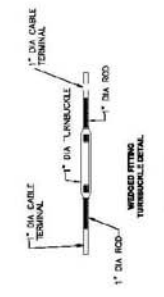

7 TABLE 1

POST SPACING	POST SIZE
0' - 17'-0"	48/LF x 4' OR 6' Post
17'-0" - 20'	56/LF x 4' Post

NOTE: SPACING IS PER 8' TYP. DEFLECTION REQUIREMENT IS. CONSULT PROJECT MANUAL FOR GRADIENT DEFLECTION IS PERMISSIBLE.

8 TABLE 2

CABLE TENSION CHART INITIAL INSTALL.	
F	LB/F
120	4624
110	4986
100	5350
90	5713
80	6077
70	6440
60	7167
50	7894
40	8619
30	9346
20	10073
10	10800
0	11525
-10	12252
-20	12979
-30	13706

9 TABLE 3

CABLE TENSION CHART MAINTENANCE	
F	LB/F
120	4021
110	4395
100	4652
90	4868
80	5284
70	5600
60	6232
50	6864
40	7495
30	8127
20	8759
10	9391
0	10022
-10	10654
-20	11286
-30	11918

WHEN SPACING IS INSUFFICIENT AND USE OF GROUNDING IS NECESSARY, ALTERNATE SOCKET PLACEMENT AS A SOCKET.

WHEN SPACING IS INSUFFICIENT AND USE OF GROUNDING IS NECESSARY, ALTERNATE SOCKET PLACEMENT AS A SOCKET.

WHEN SPACING IS INSUFFICIENT AND USE OF GROUNDING IS NECESSARY, ALTERNATE SOCKET PLACEMENT AS A SOCKET.

WHEN SPACING IS INSUFFICIENT AND USE OF GROUNDING IS NECESSARY, ALTERNATE SOCKET PLACEMENT AS A SOCKET.

WHEN SPACING IS INSUFFICIENT AND USE OF GROUNDING IS NECESSARY, ALTERNATE SOCKET PLACEMENT AS A SOCKET.

NU-CABLE TL3 CABLE SYSTEM (3 OR 4 CABLE)

SHEET 1 OF 2 DWG DATE: 10/05/2008

TITLE:	DN:	CK:	DW:
REVISIONS	DISTRICT	FEDERAL AID	PROJECT
DATE: 10/05/08	COUNTY	CONTROL	SECT
4:00:10:00:00			JOB
			F-HWAY

SOCKETED SOCKET OPTION (TYPE 5 (105))

ALTERNATE SOCKET PLACEMENT (TYPE 5 (105))

DRIVEN SOCKET OPTION (TYPE 5 (105))

DRIVEN SOCKET OPTION (TYPE 5 (105))

DRIVEN SOCKET OPTION (TYPE 5 (105))

DRIVEN SOCKET OPTION (TYPE 5 (105))

Nu-Cable™

Cable Barrier Systems

INSTALLATION MANUAL

SECTION M
APPENDIX: TESTING SOIL CONDITIONS

CONTENTS

SOIL TESTING..... 2



It's Our Nature. 

SOIL TESTING

This section includes information relevant to determining the soil density & conditions at a specific location. The processes and steps listed here are referenced throughout the manual to determine installation modifications to the system foundations required in order to maintain performance in weak, or soft, soils.

CAUTION: The options shown below are examples of typical foundations for use in strong or weak soil conditions. They should not be assumed to be the only options available. If soil conditions at each location are unknown or do not meet the minimum requirements for strong or weak soil as outlined in Section M, a geotechnical review by a professional engineer shall be conducted prior to starting installation. The results of this evaluation shall determine foundation design at each location.

In order to verify site soil as a particular soil using a DCP (Dynamic Cone Penetrometer) or SV (Shear Vane), please reference the following table and instructions:

Cohesive Soils	
Description Su (kpa)	Foundation Pile Depth CRP ANCHOR
51 - 100	450mm ø x 2500mm (18" ø x 96")
101 - 125	450mm ø x 1500mm (18" ø x 60")
Cohesionless Soils	
Description Phi (0)	Foundation Pile Depth
30 - 41	450mm ø x 2500mm (18" ø x 96")
> 41	450mm ø x 1500mm (18" ø x 60")

Table 1

- Purchase the DCP equipment.
- Purchase the ASTM publication ASTM STP 399 (available at the ASTM website) that describes the test procedure
- Submit that to the state or project engineer to make sure the tool is acceptable to them.
- The manual shows a curve that correlates the blow count from the DCP to a Standard Penetration Test (SPT) blow count. For native soil, a blow count of 15 (DCP) is equivalent to a Standard Penetration Testing (SPT) blow counts of 10 blows per foot.
- Once the SPT blow counts are known, we can use them to calculate the undrained shear strength (Su) of the cohesive soil as follows:
 - $Su \text{ (kPa)} = \text{Converted SPT blow count} \times 5$ this is the units included in the NUTEN manual
 - Or
 - $Su \text{ (ksf)} = \text{Converted SPT blow count} / 10$
- If the blow count in the field is less than 15, then the foundations will have to be increased because the soil will not qualify as stiff.
- Need to make sure whoever runs the test out in the field is familiar with the procedure. It is very easy to make a mistake about procedure of using this particular tool. Whoever performs the test in the field will have to assume responsibility for the results.
- The test should be performed in one-foot intervals down to the design bottom elevation. We are interested in the strength of the soil above (at depths of 0, 6 inches, and 2 feet) the bottom elevation because this is the soil that will provide lateral resistance to the system. You cannot just drill the holes and check the bottom.

Nu-Cable[®]

Cable Barrier Systems

INSTALLATION MANUAL

SECTION N APPENDIX: REPAIR & MAINTENANCE

CONTENTS

REPAIR & MAINTENANCE	2
Repeat Impacts.....	2
Releasing Tension	3
Cutting Cables	3
Pavement Overlays or Resurfacing.....	4
Emergency Access.....	4
Materials for Maintenance.....	4



It's Our Nature. 

REPAIR & MAINTENANCE

The Nu-Cable® System, regardless of installation method, is very easy to repair after an impact. The longitudinal elements (the cables) of the barrier will rarely need to be replaced. Visually inspect the cables, and if necessary, use cable splices to replace damaged cable.

Damaged posts and hook bolts should be replaced.

In the case of driven posts, the damaged posts must be removed and ground repaired before driving a new post.

After a significant impact it is recommended to check the tension. Also, check tension if an impact occurs close to an end terminal.



The many factors contributing to increased deflections can, in some instances, lead to maintenance and performance issues. The Nu-Cable® High-Tension System is a low-maintenance cable barrier system. Checking the tension of the cables on an annual basis, or after a severe impact, should be adequate. If impacted, a slack cable will result in increased lateral deflections. If the slack allows for a cable to become incorrectly positioned, the propensity for vehicle under-riding may increase. After all impacts, the system requires inspection and replacement or repair of damaged parts.

Repeat Impacts

High-Tension Cable barrier systems have shown capabilities of withstanding additional vehicular impacts on a damaged barrier. Due to the high tension, the cables typically do not fall to the ground as is the case with low-tension cable systems.

Releasing Tension

In certain circumstances, it may be necessary to release the tension in the system. Those may include the need to perform a repair, or a vehicle has become entangled.

There are three common ways to release the tension in the system.

1. On a short run, in a non-emergency situation, the easiest method to release tension is to open several turnbuckles to their maximum length¹. This method allows the de-tensioning and the re-tensioning to be done with hand tools.
2. Using a cable grip and a vehicle of sufficient size, attach the cable grip to the longest end of the run not affected by the accident. Drive the vehicle towards the accident to release tension. A worker can then either take out a turnbuckle or cable splice, unscrew the terminal end connector from the CRP, or cut the cable.
3. Using a ratchet come-along (note capacity²) and two cable grips, pull the cable grips toward each other to release tension. Once tension is safely removed from the section of cable to repair, remove the nearest turnbuckle or cable splice, unscrew the terminal end connector from the CRP, or cut the cable.
4. In emergency situation, the CRPs can be longitudinally run over (slowly) with a truck. The CRPs will simply lay down and release the tension. The CRP posts can be reused. It will then be needed to replace the two 5/16" (8mm) breakaway bolts.



¹ Completely unscrewing the turnbuckle or cable anchor end, or unscrewing the cable splice at all, without first removing the tension can be unsafe. The cables will move rapidly when the threads strip out of the connection. This method is not recommended.

² Most construction come-alongs are only 2000# capacity. Capacity of come-along and cable grip must be equal or greater to the amount of tension in system. Typically 8000# to 12,000# capacity will be needed.

Cutting Cables

Although it can be done, cutting cables under tension should be done with caution. It is best to first release tension in the cables by using the turnbuckles if at all possible. A vehicle becoming entrapped in the system can create a higher-than-normal tension. In an emergency, the cables CAN be cut, by using great care, with an abrasive wheel saw. Make sure no one is near the cutting point upstream or downstream. If cutting near a turnbuckle, remove adjacent posts. Use gloves and safety goggles and cut very carefully. Pay particular attention when there are only a few strands left, at the final stage of cutting. In worst case, use a bolt cutter with long handles.



Pavement Overlays or Resurfacing

Cable heights are critical to performance of the system. If the roadway has experienced an overlay, ensure cable heights are correct, and that the slope to the barrier does not exceed the maximum allowed. For significant overlays, it may be necessary to install extra-height posts.

Where it is anticipated that future roadway construction will require increases in the roadway surface elevation, a pro-active solution is to install extra-height posts in the original installation to allow for vertical adjustment of the cables. This option is only available in Test Level 3 systems.

Emergency Access

A temporary crossover for emergency vehicles or temporary traffic control can be made at any location of the installed cable barrier by removal of the special locking hook bolts and/or cable hanger straps, thus allowing the cables to slacken. The number of posts necessary for removal depends on the tension and temperature, but normally 15-40 posts will be enough. The weight of the cable will provide enough slack for passing over with vehicles.

Materials for Maintenance

Your NUCOR distributor carries an inventory of replacement parts for the Nu-Cable® System to facilitate quick repair of an impacted system. In addition, we recommend that DOTs or maintenance authorities keep a minimum quantity of repair parts on hand.

A general rule of thumb is to stock 2% to 4% of the total project, rounded up to the minimum order quantities (below).

Line Posts	=	50 piece bundles
Small Hook Bolts	=	100 pieces
Large Hook Bolts	=	50 pieces
Cable Hanger & Retainer Strap	=	50 Bundles
CRP/Trigger posts	=	3 or 4 pairs
Turnbuckles	=	3 or 4 pairs
Cable Anchor Ends	=	3 or 4 pieces
Cable Spool	=	2000 ft.

Please contact your distributor for up to date pricing on products.

Nu-Cable[®]

Cable Barrier Systems

INSTALLATION MANUAL

SECTION P
APPENDIX: CONTACT INFORMATION

CONTENTS

TECHNICAL SUPPORT AND SALES 2



It's Our Nature. 

TECHNICAL SUPPORT & SALES

Manufacturer:

NUCOR Steel Marion, Inc.
www.nucorhighway.com

Corporate Headquarters

Steve Conway
District Sales Manager
(800) 333-4011 ext. 260
Steve.Conway@nucor.com
Mailing Address:
912 Cheney Ave.
Marion, OH 43301

Manufacturer Representatives

Mark Fellows
District Sales Manager
(740) 321-1273
Mark.Fellows@nucor.com
Mailing Address:
912 Cheney Ave.
Marion, OH 43301

Chris Sanders
Inside Sales Representative
(740) 383-9637
Chris.Sanders@nucor.com
Mailing Address:
912 Cheney Ave.
Marion, OH 43301